

Section 400

2
0
2
3
-
2
0
2
4

Page Number	Vendor	Product	Sold Regionally	Publish Date
400-407	M & G Dura-Vent	DirectVent Pro Pipe		01/24
408-409	M & G Dura-Vent	Direct Vent Pro Concentric Flex Pipe		01/24
410-411	M & G Dura-Vent	(CVS) Concentric Vent System Pipe		01/24
412	M & G Dura-Vent and Reliance	Flex Accessories		01/24
412	Z-Flex	Aluminum Air Intake Ducting		02/24
412	Z-Flex	Gas Venting, Kits and Accessories		02/24
413	RH Peterson	Gas Shut-off Timer Valve		04/14
413	Sturgis	Quick Disconnect		01/14
414	Dante	Log Lighters & Valves		06/21
415	Firegear	Whistle Free Flex Connectors & Valves		11/22
416-420	Gastite and FlashShield	Flexible Gas Piping, Fittings & Accessories		08/22
421	Condar	Air Supply Ventilator		06/21

PLEASE NOTE: Not all products are sold throughout all AES territories/regions. If "Sold Regionally" please contact AES Inside Sales for availability 800-682-9722

Or by visiting...



For same day shipping, place order by: 1pm (CO), 2pm (CA, WA) and 11am (MN, TX). Give us a call at 1-800-682-9722

Associated Energy Systems - Serving you with distribution centers in: Kent, WA | West Sacramento, CA | Denver, CO | Dallas, TX | Rogers, MN

Stock: Y = Stock, N or * = Non-Stock, LTSD = Limited to Stock on Hand

Non-Stock Item Notice: Items marked non-stock must be ordered in case quantities

M & G DURA-VENT

DIRECTVENT PRO

DuraVent
Member of M&G Group

Re-Designed, Re-Engineered

With so many innovations, DirectVent GS transformed to DirectVent Pro, offering stunning design, Engineered Excellence® and utilizing state-of-the art manufacturing.

Re-Designed Appearance...All black pipe lengths and elbows feature laser-welded seams for a sleek finish. Low profile locks and no hems or beads allow for a beautiful product that looks elegant in any interior.

Re-Engineered for Excellence...Tighter inner connections, no gaskets or sealants required*. All DirectVent Pro components are compatible with DirectVent GS stock, except for the new DirectVent Pro Pipe Extensions.

*Unless specified by the appliance manufacturer.

Remarkable

Engineered Excellence® with innovation and style...DirectVent Pro... specified exclusively by nearly every major stove and fireplace manufacturer in the U.S. and Canada.



- Unitized construction eliminates field assembly of inner and outer flues.
- Twist-lock connections provide quick, positive, fastener-free installation.
- Precision pipe and fittings have been engineered for optimum appliance performance. You can rely on DirectVent Pro to provide for safe, dependable performance from your direct vent stove or fireplace.
- Laboratory tested and listed with each appliance.
- Engineered to ensure optimum appliance performance in both vertical and horizontal vent configurations.
- Wind, rain and thermal performance tested for safe, dependable operation.
- To eliminate flame lift-off and burnouts, DirectVent Pro features precision fittings that are factory leak tested. In most cases, Dura-Vent twist-lock adapters are built-in by the appliance manufacturer to ensure a leak-proof connection between the vent and the appliance.

Designer Installations Made Easy

Simpson Dura-Vent offers the most complete product line in the industry to meet every installation need. Easy to install side-wall installations offer exciting new design options. From traditional through-the-roof installations, to fireplace inserts and wood stove conversions, DirectVent Pro has the technology and component parts to make every installation a success.

Applications

DirectVent Pro has been designed for use with direct vent stoves, heaters and fireplaces. DirectVent Pro, in combination with the gas appliance, has been tested and listed as a decorative gas appliance system, or as a direct vent heater system by a major testing agency such as U.L., AGA, CGA, Warnock Hersey or Omni.

Limited Lifetime warranty

M & G DURA-VENT

4" DIRECTVENT PRO - (4" I.D. - 6-5/8" O.D.)



2
0
2
3
-
2
0
2
4

4" Galvanized Lengths and Elbows					
Item No.	Description	Pkg.	Wt./Cs.	Retail	Stocked
SD46DVA06	6" Galvanized Length	6	7 lbs.	\$53.38	Y
SD46DVA09	9" Galvanized Length	6	10 lbs.	60.89	Y
SD46DVA12	12" Galvanized Length	6	13 lbs.	70.33	Y
SD46DVA18	18" Galvanized Length	6	17 lbs.	83.55	Y
SD46DVA24	24" Galvanized Length	6	23 lbs.	96.03	Y
SD46DVA36	36" Galvanized Length	6	33 lbs.	117.27	Y
SD46DVA48	48" Galvanized Length	6	43 lbs.	140.15	Y
SD46DVA60	60" Galvanized Length	6	56 lbs.	186.76	Y
SD46DVA08A	8-1/2" Extension (3" - 7" Installed)	6	8 lbs.	52.27	Y
SD46DVA16A	16" Extension (8" - 14 1/2" Installed)	6	3 lbs.	61.99	Y
SD46DVAE45	Galvanized 45° Swivel Elbow	6	9 lbs.	94.84	Y
SD46DVAE90	Galvanized 90° Swivel Elbow	6	13 lbs.	110.95	Y
4" Black Lengths and Elbows					
SD46DVA06B	6" Black Length	1	2 lbs.	94.59	Y
SD46DVA09B	9" Black Length	1	2 lbs.	93.60	Y
SD46DVA12B	12" Black Length	1	3 lbs.	103.72	Y
SD46DVA18B	18" Black Length	1	3 lbs.	116.96	Y
SD46DVA24B	24" Black Length	1	5 lbs.	134.42	Y
SD46DVA36B	36" Black Length	1	6 lbs.	164.16	Y
SD46DVA48B	48" Black Length	1	8 lbs.	196.23	Y
SD46DVA60B	60" Black Length	1	8 lbs.	261.48	Y
SD46DVA16AB	16" Black Extension (8" - 14 1/2" Installed)	1	3 lbs.	91.41	Y
SD46DVAE45B	Black 45° Swivel Elbow	1	2 lbs.	124.09	Y
SD46DVAE90B	Black 90° Swivel Elbow	1	3 lbs.	144.95	Y
SD46DVARD	Restrictor Disk	3	1 lb.	9.82	Y
4" Supports and Firestops					
SD46DVADC	Round Ceiling Support	1	2 lbs.	\$122.34	Y
SD46DVACS	Cathedral Ceiling Support Box	1	7 lbs.	190.29	Y
SD46DVAWT	Wall Thimble	6	20 lbs.	96.03	Y
SD46DVAWTS	Slimline Wall Thimble for Sconce Terminations	6	20 lbs.	87.53	Y
SD46DVAWFS	Wall Firestop	1	4 lbs.	99.96	Y
SD46DVAWS	Wall Strap	6	4 lbs.	41.76	Y
SD46DVAFS	Ceiling Firestop	6	6 lbs.	23.14	Y



Round Ceiling Support

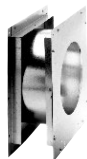

Wall Thimble



Wall Strap



Cathedral Ceiling Support Box

M & G Dura-Vent

4" DirectVent Pro - (4" I.D. - 6-5/8" O.D.)



4" Caps and Flashings					
Item No.	Description	Pkg.	Wt./Cs.	Retail	Stocked
SD46DVAVCH	High Wind Vertical Termination Cap	1	2 lbs.	\$157.94	Y
SD46DVAVC	Low Profile Vertical Termination Cap	1	2 lbs.	187.12	Y
SD46DVAVCE	Extended Vertical Termination Cap	1	4 lbs.	339.78	Y
SD46DVAHRCS	Round Horizontal Termination Cap Square Base (Aluminum)	1	5 lbs.	227.05	Y
SD46DVAHSC	Sconce Horizontal Termination Cap (Aluminum)	1	5 lbs.	260.95	Y
SD46DVAHSCS	Sconce Horizontal Termination Cap (SS)	1	5 lbs.	836.94	N
SD46DVAHSCC	Sconce Horizontal Termination Cap (Copper)	1	5 lbs.	996.05	N
SD46DVAHC	Horizontal Square Termination Cap (Aluminum)	1	5 lbs.	391.82	Y
SD46DVAHCS	Horizontal Square Termination Cap (SS)	1	5 lbs.	867.64	N
SD46DVAHCC	Horizontal Square Termination Cap (Copper)	1	5 lbs.	1,057.37	N
SD46DVAWG	Horizontal Wind Guard	1	3 lbs.	258.82	Y
SD46DVASNK14	Snorkel Termination Cap, 14"	1	11 lbs.	1,045.42	Y
SD46DVASNK36	Snorkel Termination Cap, 36"	1	17 lbs.	1,196.20	Y
SD46DVAVSS	Vinyl Siding Standoff	1	5 lbs.	126.86	Y
SD46DVAF6DS	Aluminum Flashing 0/12 - 6/12	6	15 lbs.	127.29	Y
SD46DVAF12DS	Aluminum Flashing 7/12 - 12/12	6	18 lbs.	187.55	Y
SD46DVASC	Storm Collar	6	3 lbs.	19.61	Y
SD46DVAF6	Adjustable Roof Flashing 0/12 - 6/12	6	15 lbs.	67.46	Y
SD46DVAF12	Steep Roof Flashing 7/12 - 12/12	6	18 lbs.	127.98	Y
SD46DVAFF	Flat Roof Flashing	6	20 lbs.	102.17	Y
SD46DVAES	Elbow Strap	6	6 lbs.	30.45	Y
SD46DVAIS	Attic Insulation Shield	1	5 lbs.	168.82	Y
SD46DVAVSK	Vinyl Siding Standoff Kit	1	4.4 lbs.	94.26	Y
SD46DVACFK	4" x 6 5/8" Counter Flashing	1	-	121.78	Y



Snorkel Termination Cap



Vinyl Siding Standoff



Storm Collar

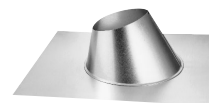

Adjustable Roof Flashing

Stock: Y = Stock, N or * = Non-Stock, LTSD = Limited to Stock on Hand

Non-Stock Item Notice: Items marked non-stock must be ordered in case quantities

Gas Venting

M & G Dura-Vent
5" DirectVent Pro - (5" I.D. - 8" O.D.)



2
0
2
3
-
2
0
2
4

5" Galvanized Lengths and Elbows					
Item No.	Description	Pkg.	Wt./Cs.	Retail	Stocked
SD58DVA09	9" Galvanized Length	4	8 lbs.	\$71.65	Y
SD58DVA12	12" Galvanized Length	4	11 lbs.	82.74	Y
SD58DVA18	18" Galvanized Length	4	15 lbs.	98.29	Y
SD58DVA24	24" Galvanized Length	4	31 lbs.	112.96	Y
SD58DVA36	36" Galvanized Length	4	29 lbs.	137.95	Y
SD58DVA48	48" Galvanized Length	4	39 lbs.	164.89	Y
SD58DVA60	60" Galvanized Length	4	39 lbs.	219.72	Y
SD58DVA08A	8" Extension	4	16 lbs.	61.55	Y
SD58DVA16A	16" Extension (8" - 14 1/2" Installed)	4	11 lbs.	77.49	Y
SD58DVAE45	Galvanized 45° Swivel Elbow	4	10 lbs.	115.75	Y
SD58DVAE90	Galvanized 90° Swivel Elbow	4	12 lbs.	135.00	Y
5" Black Lengths and Elbows					
SD58DVA06B	6" Black Length	1	2 lbs.	\$111.28	Y
SD58DVA09B	9" Black Length	1	3 lbs.	170.45	Y
SD58DVA12B	12" Black Length	1	4 lbs.	227.27	Y
SD58DVA18B	18" Black Length	1	5 lbs.	137.59	Y
SD58DVA24B	24" Black Length	1	6 lbs.	158.14	Y
SD58DVA36B	36" Black Length	1	9 lbs.	193.13	Y
SD58DVA48B	48" Black Length	1	10 lbs.	221.98	Y
SD58DVA60B	60" Black Length	1	10 lbs.	307.61	Y
SD58DVA08AB	8-1/2" Black Extension (3" - 7" Installed)	1	4 lbs.	94.54	Y
SD58DVA16AB	16" Black Extension (8" - 14 1/2" Installed)	1	4 lbs.	114.27	Y
SD58DVAE45B	Black 45° Swivel Elbow	4	3 lbs.	170.73	Y
SD58DVAE90B	Black 90° Swivel Elbow	4	4 lbs.	199.12	Y
SD58DVARD	Restrictor Disk	12	2 lbs.	21.79	Y
5" Supports and Firestops					
SD58DVADC	Round Ceiling Support	1	2 lbs.	\$140.61	Y
SD58DVACS	Cathedral Ceiling Support Box	1	7 lbs.	237.86	Y
SD58DVAFS	Ceiling Firestop	4	6 lbs.	28.92	Y
SD58DVAWFS	Wall Firestop	4	11 lbs.	122.88	Y
SD58DVAWS	Wall Strap	4	4 lbs.	47.57	Y
SD58DVAES	Elbow Strap	4	4 lbs.	38.57	Y
SD58DVAWT	Wall Thimble	4	15 lbs.	130.39	Y

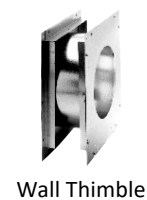

M & G Dura-Vent
5" DirectVent Pro - (5" I.D. - 8" O.D.)



5" Caps and Flashings					
Item No.	Description	Pkg.	Wt./Cs.	Retail	Stocked
SD58DVAVC	Low Profile Vertical Termination Cap	1	3 lbs.	\$213.93	Y
SD58DVAVCH	High Wind Vertical Termination Cap	1	3 lbs.	187.60	Y
SD58DVAHC	Horizontal Square Termination Cap (Aluminum)	1	6 lbs.	445.50	Y
SD58DVAHCS	Horizontal Square Termination Cap (SS)	1	5 lbs.	1,080.43	N
SD58DVAHCC	Horizontal Square Termination Cap (Copper)	1	5 lbs.	1,347.60	N
SD58DVASNK14	Snorkel Termination Cap, 14"	1	14 lbs.	1,149.98	Y
SD58DVASNK36	Snorkel Termination Cap, 36"	1	18 lbs.	1,315.83	Y
SD58DVAF6DS	Aluminum Flashing 0/12 - 6/12	6	22 lbs.	167.45	Y
SD58DVAF12DS	Aluminum Flashing 7/12 - 12/12	6	25 lbs.	311.39	Y
SD58DVACFK	Counter Flashing	1	5 lbs.	176.53	Y
SD58DVASC	Storm Collar	6	4 lbs.	32.10	Y
SD58DVAF6	Adjustable Flashing 0/12 - 6/12	6	22 lbs.	124.55	Y
SD58DVAF12	Steep Roof Flashing 7/12 - 12/12	6	25 lbs.	220.86	Y
SD58DVAFF	Flat Roof Flashing	4	18 lbs.	137.62	Y
SD58DVAIS	Attic Insulation Shield	1	9 lbs.	211.02	Y
5" Accessories					
SD58DVAX46	5/8" Reducer to 4x6 5/8	1	2.1 lbs.	\$124.47	Y



Snorkel Termination Cap



Vinyl Siding Standoff



Storm Collar

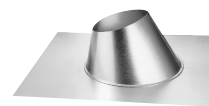

Adjustable Roof Flashing

Stock: Y = Stock, N or * = Non-Stock, LTSD = Limited to Stock on Hand

Non-Stock Item Notice: Items marked non-stock must be ordered in case quantities

M & G Dura-Vent
DuraFlex Aluminum Flex Liner



2
0
2
3
-
2
0
2
4

DuraFlex Aluminum Liner Kits

Single wall .010" (2-ply of .005") aluminum, listed to UL1777. Kit includes: Flex Length, 16" x 16" Top Plate, Cap and Mortar Sleeve

Item No.	Description	Pkg.	Wt./Cs.	Retail	Stocked
SD3DFA25K	3" x 25' DuraFlex Liner Kit	1	10 lbs.	\$360.53	Y
SD3DFA35K	3" x 35' DuraFlex Liner Kit	1	11 lbs.	425.01	Y
SD4DFA25K	4" x 25' DuraFlex Liner Kit	1	12 lbs.	383.97	Y
SD4DFA35K	4" x 35' DuraFlex Liner Kit	1	15 lbs.	468.99	Y
SD5DFA25K	5" x 25' DuraFlex Liner Kit	1	16 lbs.	454.33	Y
SD5DFA35K	5" x 35' DuraFlex Liner Kit	1	19 lbs.	633.15	N
SD6DFA25K	6" x 25' DuraFlex Liner Kit	1	22 lbs.	498.28	Y
SD6DFA35K	6" x 35' DuraFlex Liner Kit	1	24 lbs.	644.87	N



DuraFlex Liner



Flex Connector



Flex Puller

DuraFlex Aluminum Liner Only

Single wall .010" (2-ply of .005") aluminum, listed to UL1777.

SD3DFA25	3" x 25' DuraFlex Liner Only	1	7 lbs.	\$222.75	Y
SD3DFA35	3" x 35' DuraFlex Liner Only	1	9 lbs.	281.37	Y
SD3DFA50	3" x 50' DuraFlex Liner Only	1	12 lbs.	427.95	Y
SD4DFA25	4" x 25' DuraFlex Liner Only	1	10 lbs.	281.37	Y
SD4DFA35	4" x 35' DuraFlex Liner Only	1	12 lbs.	395.71	Y
SD4DFA50	4" x 50' DuraFlex Liner Only	1	16 lbs.	565.73	Y
SD5DFA25	5" x 25' DuraFlex Liner Only	1	9 lbs.	351.73	Y
SD5DFA35	5" x 35' DuraFlex Liner Only	1	14 lbs.	498.28	N

3" DuraFlex Accessories

SD3DFAFA	3" Female Flex Adapter	6	4 lbs.	\$30.87	Y
SD3DFAFC	3" Flex Connector	6	1 lbs.	25.96	Y
SD3DFSFP	3" Flex Puller	6	3 lbs.	52.06	Y
SD3DFSMS	3" Mortar Sleeve	6	4 lbs.	17.35	Y
SD3DFAT	3" Tee	6		233.93	Y
SD3DFATP	3" Top Plate	6	3 lbs.	46.91	Y
SD3DFAVC	3" Cap	6	9 lbs.	96.69	Y

4" DuraFlex Accessories

SD4DFAFA	4" Female Flex Adapter	6	5 lbs.	\$44.51	N
SD4DFAFC	4" Flex Connector	6	1 lbs.	27.82	Y
SD4DFSFP	4" Flex Puller	6	4 lbs.	68.17	N
SD4DFAT	4" Tee w/Cap	1	2 lbs.	267.06	N
SD4DFATP	4" Top Plate	6	6 lbs.	49.82	N
SD4DFAVC	4" Cap	6	4 lbs.	108.43	N



Tee w/Cap



DuraFlex Liner Kit



Cap



Masonry Sleeve



Female Adapter

Gas Venting

M & G Dura-Vent
DirectVent Pro



Termination Kits						
4" x 6-5/8", twist-lock connection provides quick, positive, fastener-free installation.						
Item No.	Description	Pkg.	Wt.	Retail	Stocked	
SD46DVAKHA	Horizontal Termination Kit A	1	16 lbs.	\$595.17	Y	
Includes: 90° Black Elbow (46DVAE90B), Wall Thimble Cover (46DVADC), 24" Length Black (46DVA24B) & 8-1/2" Pipe Extension Black (46DVA08AB). <i>Cap Not Included.</i>						
SD46DVAKHC	Horizontal Termination Kit P	1	14 lbs.	703.20	Y	
Includes: 90° Black Elbow (46DVAE90B), Wall Thimble (46DVAWT), Wall Thimble Cover (46DVADC), 24" Length Black (46DVA24B) & 8-1/2" Pipe Extension Black (46DVA08AB). <i>Cap and Adjuster Not Included.</i>						
Chimney Liner Flex Extensions						
Flexible 2 ply .010" aluminum compressed lengths. 3" flex used with co-linear system.						
SD3DFA25	3" x 25' Flex	1	7 lbs.	\$222.75	Y	
SD3DFA35	3" x 35' Flex	1	9 lbs.	281.37	Y	
Chimney Liner Termination Kit						
Chimney Liner Termination Kit connects co-linear flexible vent to co-axial termination. Kit includes termination connector and flashing. Direct Vent GS 4" x 6-5/8" termination caps, flex lengths and appliance connector are sold separately. Must be tested and listed for each appliance. Refer to your stove manufacturer's installation instructions for specifics.						
SD46DVAGK	Direct Vent Chimney Liner Termination Kit	1	6 lbs.	\$328.36	Y	
Includes: Termination Connector, Flashing.						
Complete Co-Linear Kits						
For use with inserts with 3" co-linear intake and exhaust ports. Kits include Intake and Exhaust runs, Flashing, Flex Connector and High-Wind or Prairie Cap.						
SD46DVAACL33	3" x 35' Co-Linear Kit w/High Wind Cap	1	22 lbs.	\$667.44	Y	
SD46DVAACL34	3" x 35' (Air Intake) and 4" x 25' (Exhaust) Co-Linear Kit w/High Wind Cap	1	22 lbs.	667.44	Y	
SD46DVAACL33P	3" x 35' Co-Linear Kit w/Prairie Cap	1	22 lbs.	736.48	Y	
SD46DVAACL34P	3" x 35' Intake, 4" x 35' Exhaust Co-Linear Kit w/Prairie Cap	1	22 lbs.	736.48	Y	
Co-Linear Flex Connectors						
For use with a flex connector on inserts with 3" co-linear intake and exhaust ports.						
SD46DVAADF	Co-linear Flex Connector	2	1 lb.	\$71.95	Y	
Co-axial to Co-linear Appliance Connector						
Co-Linear Adapter Connector for stoves with 4" x 6-5/8" co-axial outlets. Refer to appliance manufacturer's installation instructions. Uses 3" Flex.						
SD46DVAGCL	Standard Appliance Connector	1	3 lbs.	\$304.28	Y	
SD46DVATCL	Travis Industries Appliance Connector	1	3 lbs.	304.28	Y	
SD46DVAVCL	Vermont Castings Appliance Connector	1	3 lbs.	304.28	Y	
SD46DVAADP	Appliance Adapter	1	3 lbs.	100.45	Y	

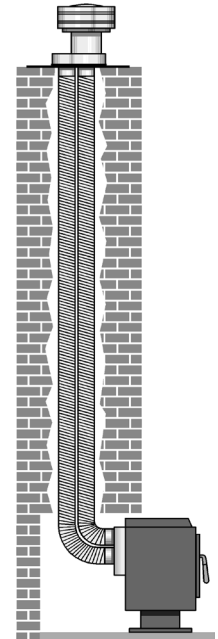

Chimney Liner Termination Kit



Co-Linear Kit w/High Wind Cap

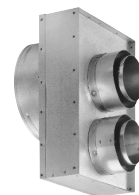

Co-axial to Co-linear Appliance Connector



Flex

Stock: Y = Stock, N or * = Non-Stock, LTSD = Limited to Stock on Hand

Non-Stock Item Notice: Items marked non-stock must be ordered in case quantities

M & G Dura-Vent
DirectVent Pro



2
0
2
3
-
2
0
2
4

Masonry Chimney Conversion Kits					
Class A Chimney Masonry Conversion Kit for 4" x 6-5/8" Direct Vent gas stoves. Change out existing wood burning stoves to direct vent gas stoves.					
Item No.	Description	Pkg.	Wt.	Retail	Stocked
SD46DVAKMC	Masonry Conversion Kit	1	7 lbs.	\$489.68	Y
Kit includes: Cap Adapter, 18" x 18" flashing, round ceiling support/wall thimble cover and retro connector. Purchase 4" flex extension and termination cap separately.					
SD46DVAKCT	Masonry Conversion Kit	1	3 lbs.	189.27	Y
Kit includes: Cap Adapter and 18" x 18" flashing.					

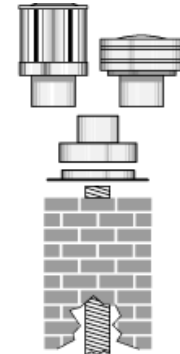

Masonry Conversion Kit

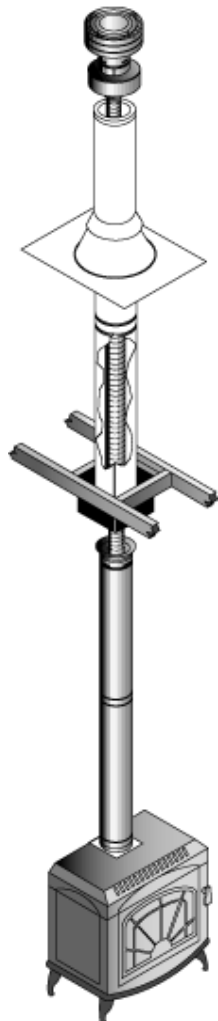

Class A Chimney Conversion Kits					
Class A Chimney Conversion Kit for 4" x 6-5/8" Direct Vent gas stoves. Change out existing woodburning stoves to direct vent gas stoves through existing class A chimney system. Chimney Conversion Kits include cap adapter and a retro connector collar. Purchase 4" flex extension and termination cap separately.					
Item No.	Description	Pkg.	Wt.	Retail	Stocked
SD46DVAKCA	Conversion Kit A	1	3 lbs.	\$406.38	Y
Fits the following chimneys or others with a 6" I.D. and up to 8" O.D.: Metalbestos, Pro-Jet, Hart & Cooley, ICC, Security, Jackes-Evans.					
SD46DVAKCB	Conversion Kit B	1	3 lbs.	406.38	Y
Fits the following chimneys or others with 6-8" I.D. and up to 10" O.D.: Simpson Dura-Vent (6" I.D.), Jackes-Evans (7" & 8" I.D.), Air-Jet (6" I.D.), Hart & Cooley (7" & 8" I.D.), ICC (7" & 8" I.D.), Metal-Fab (6" & 7" I.D.), Pro-Jet (7" & 8" I.D.), American Metal (6" & 7" I.D.), Security (8" I.D.), Metalbestos (7" & 8" I.D.).					
SD46DVAKCC	Conversion Kit C	1	3 lbs.	406.38	Y
Fits the following chimneys or others with 7-8" I.D. and up to 12" O.D.: Simpson Dura-Vent (7" & 8" I.D.), Air-Jet (8" I.D.), American Metals (8" I.D.), Metal-Fab (8" I.D.).					

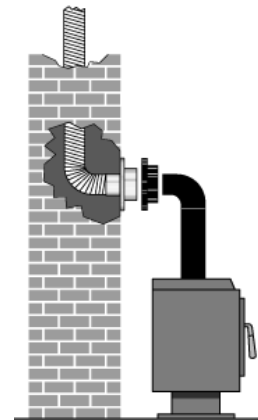

M & G DURA-VENT

DIRECTVENT PRO CONCENTRIC FLEX



DuraVent
Member of M&G Group

Versatility and Simplicity

Concentric Flex can be used as a cost-effective alternative to 45-degree elbows when offsetting around an obstacle such as a stud, joint or truss. It allows you to put the vent EXACTLY where you need it, and in a hurry. Using this approach can speed up installation time, save on parts, and help to minimize the number of joints between pipe sections.

We have all been there. The customer wants the fireplace positioned in such a way that the outlet always seems to line up with an obstacle – like a wall stud, electrical wiring, or vent stack for plumbing. No problem! DirectVent Pro Concentric Flex allows you to quickly adjust the positioning of the vent to hit the desired stud space in any up & out or cross-corner installation. The same is true for a joist or truss in vertical installations.

Single-offset? Double-offset? Simply adjust a length of DVP Concentric Flex to suit the application.

Key Features and Benefits

Fully compatible with DirectVent Pro. This gives you the best of both worlds - the robust, long-lasting, professional reputation of our rigid system combined with the infinite convenience of concentric flex when you need it, where you need it.



Twist-Lock Connection

Our concentric flex features the same twist-lock you already know. This makes assembly easy on fireplaces that are already equipped with a twist-lock outlet. No need for messy sealants or screws here. This also allows you to use concentric flex in combination with other DirectVent Pro parts you already have in the truck or on the shelf.

Factory-Installed Spacer

DVP Concentric Flex comes with a factory-installed spacer. This eliminates the fear associated with hot-spots and compromised clearances-to-combustibles. With field-assembled product, spacers can be overlooked or misplaced at the wrong intervals. Spacers can also slip out of place. Not only is our spacer firmly attached, it runs continuously through each length from one end to the other. This results in a consistent air gap between the inner flue and outer air intake.

Unique Overlapping Collar Design

Unlike systems offered by competitors, there is no need to improvise when attempting to attach flex on the downstream end of the vent. Simply twist-lock the pipe together as you normally would, then pull the outer flex up into place, and fasten the two overlapping collars together using supplied screws. Quick, simple, and easy with no compromises.

Three Convenient Lengths

DirectVent Pro Concentric Flex is available in 3-foot, 5-foot, and 10-foot lengths for use with DirectVent Pro 46DVA and 58DVA venting. Each length ships from the factory compressed within a compact box. The smaller packaging takes up less space on the shelf and in the truck during transport. At the jobsite, the inner and outer lengths are easily stretched independently to your exact requirements.

Construction

The inner and outer flex on DirectVent Pro Concentric Flex is made with two-ply aluminum. It is designed to withstand the high heat of exhaust emitted from any approved gas fireplace. The outer's role is to conduct combustion air and is robust enough to meet all impact and puncture test requirements.

M & G DURA-VENT
DIRECTVENT PRO CONCENTRIC FLEX



2
0
2
3
-
2
0
2
4

4" Lengths						
Item No.	Description	Pkg.	Wt./Cs.	Retail	Stocked	
SD46DVA36FF	(4x6) 36" Concentric Flex Length		4 lbs.	\$252.04	Y	
SD46DVA60FF	(4x6) 60" Concentric Flex Length		5 lbs.	329.05	Y	
SD46DVA120FF	(4x6) 120" Concentric Flex Length		12 lbs.	574.09	Y	
5" Lengths						
SD58DVA36FF	(5x8) 36" Concentric Flex Length		5 lbs.	294.05	Y	
SD58DVA60FF	(5x8) 60" Concentric Flex Length		9 lbs.	392.06	Y	
SD58DVA120FF	(5x8) 120" Concentric Flex Length		14 lbs.	679.11	Y	

M & G Dura-Vent

CVS - Concentric Vent System - Stainless Steel Liner



CVS Lengths				
Item No.	Description	Pkg.	Retail	Stocked
SD35CVS06	3"x5" CVS 6" Pipe Length	6	\$57.29	Y
SD35CVS06B	3"x5" CVS 6" Pipe Length BLACK	6	112.48	N
SD35CVS12	3"x5" CVS 12" Pipe Length	6	88.01	Y
SD35CVS12B	3"x5" CVS 12" Pipe Length BLACK	6	112.49	N
SD35CVS24	3"x5" CVS 24" Pipe Length	6	97.20	Y
SD35CVS24B	3"x5" CVS 24" Pipe Length BLACK	6	162.23	N
SD35CVS36	3"x5" CVS 36" Pipe Length	6	120.73	Y
SD35CVS36B	3"x5" CVS 36" Pipe Length BLACK	6	186.69	N
CVS Adjustable Lengths				
SD35CVS12TA	3"x5" CVS 12" Telescoping Adjustable Pipe Length	6	\$129.93	Y
SD35CVS18TA	3"x5" CVS 18" Telescoping Adjustable Pipe Length	6	255.68	Y
SD35CVS18TAB	3"x5" CVS 18" Telescoping Adjustable Pipe Length BLACK	6	285.29	N
CVS Flashings				
SD35CVSDSA	3"x5" CVS Dead Soft Adjustable Flashing 0/12 - 6/12 Pitch	1	\$131.78	Y
SD35CVSF	3"x5" CVS Adjustable Flashing 0/12 - 6/12 Pitch	1	40.00	Y
CVS Elbows				
SD35CVSE45	3"x5" CVS 45 Degree Elbow	6	\$122.77	Y
SD35CVSE45B	3"x5" CVS 45 Degree Elbow BLACK	6	172.42	N
SD35CVSE90	3"x5" CVS 90 Degree Elbow	6	130.68	Y
SD35CVSE90B	3"x5" CVS 90 Degree Elbow BLACK	6	184.68	N
CVS Tees				
SD35CVST	3"x5" Tee w/Cleanout	-	\$275.45	N
SD35CVSTB	3"x5" Tee w/Cleanout BLACK	-	304.97	N
CVS Caps				
SD35CVSHCR	3"x5" CVS Horizontal Cap	1	\$284.07	Y
SD35CVSVC	3"x5" CVS Vertical Cap	1	374.99	Y

More CVS on next page...



Stock: Y = Stock, N or * = Non-Stock, LTSD = Limited to Stock on Hand

Non-Stock Item Notice: Items marked non-stock must be ordered in case quantities

M & G Dura-Vent

CVS - Concentric Vent System - Stainless Steel Liner



2
0
2
3
-
2
0
2
4

CVS Accessories (Supports, Collars, Plates, etc.)				
Item No.	Description	Pkg.	Retail	Stocked
SD35CVSFS	3"x5" CVS Firestop Support	1	\$45.45	Y
SD35CVSRS	3"x5" CVS Roof Support	1	38.88	N
SD35CVSIS	3"x5" CVS Attic Insulation Shield	1	192.05	Y
SD35CVSSC	3"x5" CVS Storm Collar	1	13.81	Y
SD35CVSTRO	3"x5" CVS Exterior Trim Plate	12	12.30	Y
SD35CVSTRI	3"x5" CVS Interior Trim Plate	-	11.31	N
SD35CVSWP10	3"x5" CVS Wall Plate 10x10	12	31.20	Y
SD35CVSWS	3"x5" CVS Wall Strap	12	44.31	Y
SD35CVSWT	3"x5" CVS Wall Thimble	1	126.87	Y
SD35CVSWTP	3"x5" CVS Wall Thimble (Includes Insulation Ring)	1	149.53	Y
SD35CVSCD	3"x5" CVS Universal Condensate Drain	-	227.13	N
SD35CVSCDB	3"x5" CVS Universal Condensate Drain BLACK	-	266.96	N
SD35CVSTI	3"x5" CVS Air Instake Manifold	-	192.82	N
SD35CVSTIB	3"x5" CVS Air Instake Manifold BLACK	-	216.43	N
CVS In increaser/Reducer				
SD35CVSX3PVP	3" Diameter Increaser 35CVS	1	\$129.86	Y
SD35CVSX3PVPB	3" Diameter Increaser 35CVS BLACK	1	155.43	Y
SD35CVSX46DVA	3"X5" Diameter Increaser (to 4"X6" DVA)	-	155.42	Y
SD35CVSX58DVA	3"X5" Diameter Increaser (to 5"X8" DVA)	-	167.86	Y
SD46DVAX35CVS	4"X6" Diameter Decreaser (to 3"X5" CVS)	-	152.32	Y
SD58DVAX35CVS	5"X8" Diameter Decreaser (to 3"X5" CVS)	-	167.86	Y
SD35CVST3	3"x5" CVS Increaser Tee w/Cleanout	-	259.71	N
SD35CVST3B	3"x5" CVS Increaser Tee w/Cleanout BLACK	-	285.29	N

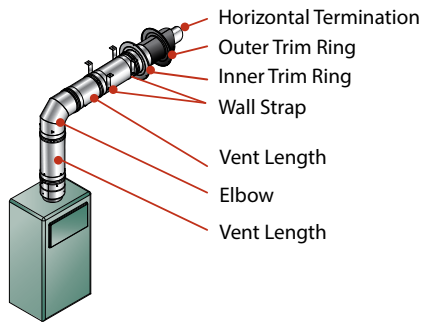

Horizontal Gas Installation

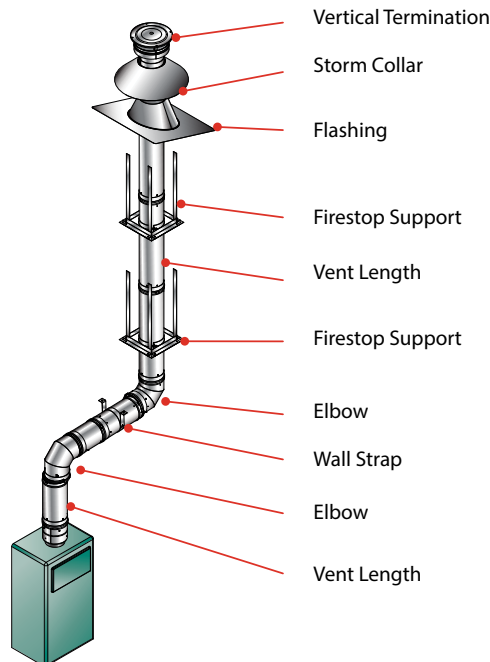

Vertical Gas Installation

Aluminum Flex Liner Accessories

3" Accessories			
Item No.	Description	Retail	Stocked
SD3DFAFC	3" Universal Adapter to Flex Connector	\$25.96	Y
	For connecting aluminum flex to B-vent		
RM3NC	3" Nose Cone	47.00	N
4" Accessories			
SD4DFAFC	4 Universal Adapter to Flex Connector	\$27.82	Y
	For connecting aluminum flex to B-vent		

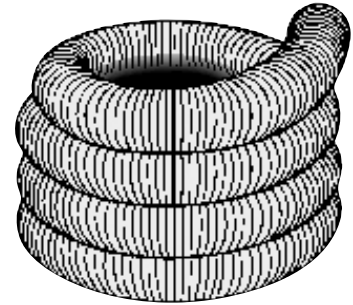

Aluminum Flex Air Ducting

Aluminum Air Intake Ducting			
A certified air connection hose, providing combustion air for fireplaces and stoves. Single wall aluminum .005 thickness.			
Item No.	Description	Retail	Stocked
ZFAF225	(ZF1TLXXX0225) 2" x 25' Aluminum Flex Duct	\$91.00	Y
ZFAF525	(ZF2GAXXX0525) 5" x 25' Aluminum Flex HVAC Duct	203.00	Y
ZF2FAKXX04	10' Fresh Ar Kit Includes Alum. Flex 10' Insulation Sleeve Exterior Intake Hood & 2 Clamps	133.00	Y



Aluminum Air Intake Ducting

Gas Venting, Kits and Accessories

Gas Venting, Kits and Accessories			
Item No.	Description	Retail	Stocked
ZF2DV4705	DV Gas Kit - 4/7" x 5' Co-Axial - Flex Only	\$294.00	Y
ZF2DV4710	DV Gas Kit - 4/7" x 10' Co-Axial - Flex Only	437.00	Y
ZF2DV5805	DV Gas Kit - 5/8" x 5' Co-Axial - Flex Only	335.00	Y
ZF2DV5810	DV Gas Kit - 5/8" x 10' Co-Axial - Flex Only	497.00	Y
ZF2DVK40705HT	DV Gas Horizontal Square Term Kit - 4/7" x 5' - Includes Flex, Spacers, Supports and Screws	\$498.00	Y
ZF2DVK40710HT	DV Gas Horizontal Square Term Kit - 4/7" x 10' - Includes Flex, Spacers, Supports and Screws	699.00	Y
ZF2DVK50805HT	DV Gas Horizontal Square Term Kit - 5/8" x 5' - Includes Flex, Spacers, Supports and Screws	698.00	Y
ZF2DVK50810HT	DV Gas Horizontal Square Term Kit - 5/8" x 10' - Includes Flex, Spacers, Supports and Screws	766.00	Y
ZF2DVC47	DV Gas 4/7" Coupler	99.00	Y
ZF2DVC58	DV Gas 5/8" Coupler	106.00	Y
ZF2DVFS47	DV Gas 7" Firestop	54.00	Y
ZF2DVFS58	DV Gas 8" Firestop	56.00	Y
ZF2DVWT47	DV Gas 4/7" Thimble	83.00	Y
ZF2DVWT58	DV Gas 5/8" Thimble	88.00	Y

Stock: Y = Stock, N or * = Non-Stock, LTSD = Limited to Stock on Hand

Non-Stock Item Notice: Items marked non-stock must be ordered in case quantities

Gas Venting

RH Peterson
Gas Timer Valve

Automatic 3 Hour Timer Gas Safety Shut-Off Valve			
RH Peterson Safety Timer offers additional safety by automatically shutting off the gas flow at pre-set times. Features a flow capacity of 100,000 BTUs. Can be used for Natural Gas or Propane.			
<i>Item No.</i>	<i>Description</i>	<i>Retail</i>	<i>Stocked</i>
RH3090	F.M. Automatic Timer Safety Shut-Off Valve - 3 Hour	\$85.00	Y
RH3092A	F.M. Automatic Timer Safety Shut-Off Valve - 1 Hour	85.00	Y



Gas Timer Valve

Quick Disconnect

The improved M.B. Sturgis appliance connector meets or exceeds the temperature, pull, and crush requirements of the ANSI Z21.54 standard for portable appliance connectors. These connectors are commonly used with outdoor residential cooking equipment, outdoor commercial and non-commercial cooking equipment, heaters, generators, and many other applications. M.B. Sturgis can manufacture gas hose connectors from 3/8" ID to 2" ID.

Quick Disconnect

<i>Item No.</i>	<i>Description</i>	<i>Retail</i>	<i>Stocked</i>
AES103186144	Sturgis 12' NG/LP Hose With Quick Disconnect	\$59.00	Y
AES104007	Sturgis 3/8" NG Quick Disconnect w/Ball Valve Assy (Shut-off Valve)	46.90	Y
AES104116	Sturgis LP Quick Disconnect 1/4" FPT (For Use w/5 Gal. LP Tank	31.80	N
AES104406P	*Sturgis Safe 375 Quick Disconnect Assembly for 103003144 - SPECIAL ORDER	31.80	N



2
0
2
3
-
2
0
2
4

Gas Venting

Dante
Log Lighters & Valves

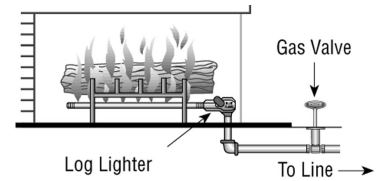

Log Lighters				
30,000 BTU. 17" Standard. 15 jet burner holes. Includes log lighter only.				
Item No.	Description	Pkg.	Retail	Stocked
CE611NG	Straight/Angled, Natural Gas, Carded	12	\$42.00	Y
CE611LP	Straight/Angled, LP Gas, Carded	12	42.00	Y

Dante Gas Valves with Key				
This is the only valve on the market machined out of solid brass stock. Soft seat globe type valve that eliminates porosity problems found in sand casting valves. Certified by CSA International. Withstands up to 50 lbs. of pressure. Valve comes with 1/4" key and floor plate.				
Item No.	Description	Pkg.	Retail	Stocked
CECP910BR	Straight, Polished Brass - Globe Valve	36	\$46.00	Y
CECP910CR	Straight, Polished Chrome - Globe Valve	36	46.00	Y
CECP911BR	Angled, Polished Brass - Globe Valve	36	46.00	Y
CECP911CR	Angled, Polished Chrome - Globe Valve	36	46.00	Y
3" Replacement Keys				
CENKY3CR	Polished Chrome 1/4" and 5/16", Universal Key		9.00	Y
CENKY3BR	Polished Brass 1/4" and 5/16", Universal Key		9.00	Y
8" Replacement Keys				
CENKY8CR	Polished Chrome 1/4" and 5/16", Universal Key		14.00	Y
CENKY8BR	Polished Brass 1/4" and 5/16", Universal Key		14.00	Y
12" Replacement Keys				
CENKY12CRB	Polished Chrome 1/4" and 5/16", Universal Key		20.00	Y
CENKY12BRB	Polished Brass 1/4" and 5/16", Universal Key		20.00	Y
18" Replacement Keys				
CENKY18CRB	Polished Chrome 1/4" and 5/16", Universal Key		27.00	N
CENKY18BRB	Polished Brass 1/4" and 5/16", Universal Key		27.00	N
24" Replacement Keys				
CENKY24BRB	Polished Brass 1/4" and 5/16", Universal Key		37.00	N
Accessories				
CEFPGVBR	Polished Brass Floor Plate		11.00	N
CEFPGVCR	Polished Chrome Floor Plate		11.00	Y



Log Lighter



Log Lighter



1/4 Turn Ball Valves

Firegear
Flex Connectors & Valves



2
0
2
3
-
2
0
2
4

Firegear Whistle Free Black Coated Flex Connectors w/Fitting

Item Number	Description	Retail	Stocked
FGT102213212	3/8" OD 3/8" MIP x 1/2" FIP x 12" - Black Coated	\$25.85	LTSD
FGT102213218	3/8" OD 3/8" MIP x 1/2" FIP x 18" - Black Coated	35.10	LTSD
FGT102213224	3/8" OD 3/8" MIP x 1/2" FIP x 24" - Black Coated	40.00	LTSD
FGT102213230	3/8" OD 3/8" MIP x 1/2" FIP x 30" - Black Coated	47.00	LTSD
FGT102213236	3/8" OD 3/8" MIP x 1/2" FIP x 36" - Black Coated	59.25	LTSD
FGT202213212	1/2" OD 3/8" MIP x 1/2" FIP x 12" - Black Coated	31.70	LTSD
FGT202213218	1/2" OD 3/8" MIP x 1/2" FIP x 18" - Black Coated	40.10	LTSD
FGT202213224	1/2" OD 3/8" MIP x 1/2" FIP x 24" - Black Coated	49.05	LTSD
FGT202213230	1/2" OD 3/8" MIP x 1/2" FIP x 30" - Black Coated	57.65	LTSD
FGT202213236	1/2" OD 3/8" MIP x 1/2" FIP x 36" - Black Coated	64.25	LTSD

Firegear Whistle Free Stainless Steel Flex Connectors w/Fitting

The following connectors will not ship until stock of it's discontinued counterpart above has been depleted.

Item Number	Description	Retail	Stocked
FGT200989810	1/2" OD (3/8" ID) x 10", with 1/2" OD Flare Nuts	\$19.00	TBD
FGT200989816	1/2" OD (3/8" ID) x 16", with 1/2" OD Flare Nuts	29.00	TBD
FGT200989822	1/2" OD (3/8" ID) x 22", with 1/2" OD Flare Nuts	39.00	TBD
FGT200989828	1/2" OD (3/8" ID) x 28", with 1/2" OD Flare Nuts	49.00	TBD
FGT200989834	1/2" OD (3/8" ID) x 34", with 1/2" OD Flare Nuts	49.00	TBD
FGT200989846	1/2" OD (3/8" ID) x 46", with 1/2" OD Flare Nuts	59.00	TBD

GAS BTU RATING FOR FIREGEAR FLEX CONNECTORS



Type	12"	18"	24"	30"	36"	48"
3/8" OD	48,000	43,600	40,000	36,400	33,400	-
1/2" OD	102,000	93,100	85,000	77,100	60,500	

Firegear Shut-Off Valves

Item Number	Description	Retail	Stocked
FG01387	3/8" Flare x 1/2" FIP Brass Straight Valve 25/cs	\$19.50	LTSD
FG01487	1/2" Flare x 1/2" FIP Gas Valve 25/cs	20.70	LTSD
FG01266	Flare Ball Valve 3/8" OD Flare x 3/8" OD Flare	16.00	LTSD
FG01288	Flare Ball Valve 1/2" OD Flare x 1/2" OD Flare	17.50	LTSD

Firegear Key Valves

Item Number	Description	Retail	Stocked
FGKEYPC12	12" Polished Chrome Key for Key Valve	\$19.00	N
FGKVPC12	High Capacity Straight Key Valve with Polished Chrome Cover and 12" Key, 350,000 BTU @ 1/2 PSI	89.00	Y

Gastite
Flexible Gas Piping



Flexible Gas Piping

Item Code	Item Name	Ship Weight	Retail Price	Stocked
Mounting Kits (Sold Per Box)				
TFGLC1	Gas Load Center Kit 14 1/2" x 24" x 3 1/2"	12 lbs.	\$ 448.70	N
TFMBRACE110	Manifold Mounting Kit	2 lbs.	\$ 33.12	N
TFLBRACE120	Termination Mounting Kit Fits 3/8", 1/2", 3/4", 1" CSST	1 lbs.	\$ 9.25	N
Mainfolds				
Shop assembled tee/close nipple manifolds are also approved for system use.				
TF3PORTMAN	Cast 3 Port w/PT Port - 3/4" F x 3@1/2" F x 1/2" F	2 lbs.	\$ 75.95	N
TF4PORTMAN10	Cast 4 Port w/PT Port - 3/4" F x 4@1/2" F x 1/2" F	2 lbs.	\$ 83.51	N
TF5PORTMAN1	Cast 5 Port w/PT Port - 3/4" F x 1@3/4" F x 4@1/2" F x 1" F	2 lbs.	\$ 104.45	N
Metal Tubing Straps				
TFMSTRAPS8250	Fits 1/2" Tubing, Sold per box	5 lbs.	\$ 0.25	N
TFMSTRAPS11150	Fits 3/4" Tubing, Sold per box	3 lbs.	\$ 0.29	N
TFMSTRAPS16100	Fits 1" Tubing, Sold per box	4 lbs.	\$ 0.72	N
TFMSTRAPS2050	Fits 1-1/4" Tubing, Sold per box	3 lbs.	\$ 1.12	N
Striker Plates				
Helps protect tubing from accidental puncture by nails, etc.				
TFM20525	Full Striker Plate, 3" x 12"	1 lbs.	\$ 10.32	N
TFM20150	Half Striker Plate, 3" x 7"	1 lbs.	\$ 5.40	Y
TFM204100	Quarter Striker Plate, 3" x 2"	2 lbs.	\$ 2.24	Y
TFM21010	Striker Plate, 6" x 17"	2 lbs.	\$ 42.34	N
Steel Conduit				
Helps protect tubing from damage in potential puncture areas. Sold in coils only.				
TFFLOPPY12	3/4" fits 3/8" CSST	8 lbs.	\$ 178.91	N
TFFLOPPY16	1" fits 1/2" CSST	13 lbs.	\$ 263.37	N
TFFLOPPY20	1-1/4" fits 3/4" CSST	11 lbs.	\$ 192.05	N
TFFLOPPY24	1-1/2" fits 1" CSST	13 lbs.	\$ 240.72	N
TFSILTAPPE	Self Bond Silicone Tape Roll, 1" x 0.015"	1 lbs.	\$ 55.81	N

Stock: Y = Stock, N or * = Non-Stock, LTSD = Limited to Stock on Hand

Non-Stock Item Notice: Items marked non-stock must be ordered in case quantities

Gastite

Flexible Gas Piping & Underground Gas Piping



2
0
2
3
-
2
0
2
4

Flexible Gas Piping				
Item Code	Item Name	Ship Weight	Retail Price	Stocked
Quick Connects				
TFT103029	Quick Connect Valve, 1/2" NPT	1 lbs.	\$ 186.01	Y
TFOUTFLEX38	Outdoor Flex Connector, 3/8" NPT x 12'	3 lbs.	TBD	N
Tooling				
TFGTCUTTERS2	Tubing Cutter with Flat Rollers, 3/8" - 1"	2 lbs.	\$ 176.25	Y
TFGTBLADESM5	Replacement Blade for GTCUTTERS2	1 lbs.	\$ 50.81	N
TFSTRP481124	1/2" - 3/4" Jacket Stripping Tool	2 lbs.	\$ 47.17	N
TFSTRP4162024	1" - 1 1/4" Jacket Stripping Tool	3 lbs.	\$ 54.24	N
Shut-Off Valves				
TFT1001/2-20	NPT 1/2" Ball Valve	1 lbs.	\$ 55.51	N
TFT1003/4-10	3/4" Ball Valve, Rated to 125 PSI	1 lbs.	\$ 85.89	N
Maxitrol Regulators				
TFT325344	250 MBTU of NG (8" w.c. outlet), 1/2" NPT	1 lbs.	\$ 103.54	Y
TFT325544	600 MBTU of NG (8" w.c. outlet), 3/4" NPT	2 lbs.	\$ 242.39	Y
OARA Regulators				
TFREG11300	355 MBTU of LP (11" w.c. outlet), 1/2" NPT	1 lbs.	\$ 103.54	N
TFREG8600	550 MBTU of NG (8" w.c. outlet), 3/4" NPT	2 lbs.	\$ 190.34	N

Gastite

Underground Gas Piping & FlashShield Flexible Gas Piping



Underground Gas Piping

A complete "stab-on" polyethylene gas piping system for underground applications which eliminates corrosive threats associated with metallic piping. This system is designed, tested and certified for direct burial and has the lowest installation costs compared to other underground gas piping materials. No rigid pipe cutting, threading and welding. No protective sleeve required. No heat welding typically associated with other PE piping systems. Minimal tools required and assembles in minutes with permasert stab-on fittings and continuous lengths of flexible piping.

Item Code	Item Name	Ship Weight	Retail Price	Stocked
Polyethylene Tubing				
Sold in 250' coils only				
TFPE8250	PE Tubing, 1/2" CTS	1 lbs.	\$ 275.00	N
TFPE16250	PE Tubing, 1" CTS	1 lbs.	\$ 495.00	Y
Line Risers With Permasert Coupling				
TFRISER818	1/2" CTS x 18" Vertical	4 lbs.	\$ 126.48	N
TFRISER830	1/2" CTS x 30" Vertical	5 lbs.	\$ 168.55	N
TFRISER1630	1" CTS x 30" Vertical	8 lbs.	\$ 237.53	Y
TFRBRACE1	Riser Bracket, All Sizes	4 lbs.	\$ 99.77	N
Mechanical Accessories				
TFPECPL847.43	(TFPECPL8) PE Coupling, 1/2" CTS	1 lbs.	\$ 53.78	N
TFPECPL16	PE Coupling, 1" CTS	1 lbs.	\$ 76.74	Y
TFPET8	PE Tee Fitting, 1/2" CTS	1 lbs.	\$ 189.25	N
TFPET16	PE Tee Fitting, 1" CTS	1 lbs.	\$ 306.03	N
Tools and Accessories				
TFCHTOOL816	Chamfering Tool, 1/2" CTS x 1" CTS	1 lbs.	\$ 69.29	N
TFPECUTTER	PE Tubing Cutter, 1/2", Up to 1 1/4"	1 lbs.	\$ 73.82	N
TFPEBLADE	Replacement PE Blade for TF-PE CUTTER	1 lbs.	\$ 29.03	N
TFMAGTAPE	Magnetic Tape, 2" x 1,000 ft.	1 lbs.	\$ 161.66	N

FlashShield by Gastite
FlashShield Flexible Gas Piping



2
0
2
3
-
2
0
2
4

FlashShield by Gastite - Flexible Gas Piping

FlashShield™ is CSA design certified to ANSI LC1-2005 for "Fuel Gas Piping Systems Using Corrugated Stainless Steel Tubing (CSST)." CSST supplies natural gas or liquefied petroleum gas (LP gas) to appliances. Simple hand tools such as tubing cutters, wrenches and utility knives are all that are needed to work with the FlashShield™ components. FlashShield™ is a reliable, cost-effective system that can be installed in all modes of construction: residential, commercial and industrial; new construction and retrofits.
*All FlashShield (FS) Fittings and Tees can be used with Yellow Gastite CSST.

Item Code	Item Name	Ship Weight	Retail Price	Stocked
FlashShield Corrugated Stainless Steel Tubing (CSST)				
Priced per foot. Minimum cut is 50' lengths.				
TFFSP850	1/2" FlashShield CSST - SOLD BY 50' INCREMENTS	9 lbs.	\$ 508.00	Y
TFFSP8125	1/2" FlashShield CSST - SOLD BY 125' INCREMENTS	29 lbs.	\$ 1,202.50	N
TFFSP8255	1/2" FlashShield CSST - SOLD BY 125' INCREMENTS	23 lbs.	\$ 1,286.25	N
TFFSP8250	1/2" FlashShield CSST - SOLD BY 250' INCREMENTS	50 lbs.	\$ 2,405.00	Y
TFFSP8500	1/2" FlashShield+ CSST - SOLD BY 500' INCREMENTS	95 lbs.	\$ 4,810.00	N
TFFSP1150	3/4" FlashShield CSST - SOLD BY 50' INCREMENTS	11 lbs.	\$ 659.00	N
TFFSP11255	3/4" FlashShield CSST - SOLD BY 125' INCREMENTS	29 lbs.	\$ 1,671.25	N
TFFSP11125	3/4" FlashShield CSST - SOLD BY 125' INCREMENTS	34 lbs.	\$ 1,562.50	N
TFFSP11250	3/4" FlashShield CSST - SOLD BY 250' INCREMENTS	64 lbs.	\$ 3,125.00	Y
TFFSP11500	3/4" FlashShield CSST - SOLD BY 500' INCREMENTS	117 lbs.	\$ 6,250.00	N
TFFSP1650	1" FlashShield CSST - SOLD BY 50' INCREMENTS	24 lbs.	\$ 951.50	N
TFFSP1675	1" FlashShield CSST - SOLD BY 75' INCREMENTS	31 lbs.	\$ 1,335.00	N
TFFSP16150	1" FlashShield CSST - SOLD BY 150' INCREMENTS	58 lbs.	\$ 2,670.00	Y
TFFSP16300	1" FlashShield CSST - SOLD BY 300' INCREMENTS	104 lbs.	\$ 5,340.00	N
TFFSP16500	1" FlashShield CSST - SOLD BY 500' INCREMENTS	175 lbs.	\$ 8,900.00	N
FlashShield XR3 Self-Flaring Straight Mechanical Fittings				
Includes adapter, nut and bushing.				
TFXR3FTG824	1/2" Flashshield XR3 Straight - 1/2" NPT	1 lbs.	\$ 35.73	Y
TFXR3FTG1124	3/4" Flashshield XR3 Straight - 3/4" NPT	1 lbs.	\$ 49.15	Y
TFXR3FTG1612	1" Flashshield XR3 Straight - 1" NPT	1 lbs.	\$ 75.95	Y
FlashShield XR3 Termination Fitting				
Includes square-black flange adapter, nut and bushing.				
TFXR3TRM812	1/2" Flashshield XR3 Term. w/Square Flange -1/2" NPT	1 lbs.	\$ 48.89	Y
TFXR3TRM1112	3/4" Flashshield XR3 Term. w/Square Flange -3/4" NPT	1 lbs.	\$ 53.98	Y
TFXR3TRM166	1" Flashshield XR3 Term. w/Square Flange - 1"NPT	1 lbs.	\$ 87.20	N
FlashShield XR3 Female Fitting				
Includes adapter, nut and bushing.				
TFXR3FTGFM824	1/2" FlashShield XR3 Straight Fitting - 1/2" Female NPT	1 lbs.	\$ 35.73	Y
TFXR3FTGFM11824	3/4" FlashShield XR3 Straight Fitting - 1/2" Female NPT	1 lbs.	\$ 52.55	N
TFXR3FTGFM1124	3/4" FlashShield XR3 Straight Fitting - 3/4" Female NPT	1 lbs.	\$ 49.15	Y
FlashShield XR3 Reduce Fitting				
Includes adapter, nut and bushing.				
TFXR3REDFTG118	3/4" FlashShield XR3 Reducing Fitting - 1/2" NPT	1 lbs.	\$ 75.38	N
TFXR3REDFTG1612	1" FlashShield XR3 Reducing Fitting - 3/4" NPT	1 lbs.	\$ 112.54	N

Gas Venting

FlashShield by Gastite

FlashShield Flexible Gas Piping



FlashShield by Gastite

FlashShield XR3 Bronze Self-Flaring Termination Fittings

Includes rustproof, decorative cast bronze flange, adapter, flange nut and bushing.

Item Code	Item Name	Ship Weight	Retail Price	Stocked
TFXR3TRM8CB12	1/2" FlashShield XR3 Term. Bronze Flng 1/2" NPT	1 lbs.	\$ 72.15	Y
TFXR3TRM11CB12	3/4" FlashShield XR3 Term. Bronze Flng 3/4" NPT	1 lbs.	\$ 97.01	Y
TFXR3TRM16CB6	1" FlashShield XR3 Term. Bronze Flng 1" NPT	1 lbs.	\$ 148.93	N

FlashShield XR3 Termination Bracket Fittings

Includes bracket, bronze flange, adapter, nut and bushing.

TFXR3TRMBKT812	1/2" FlashShield XR3 Term. Bkt. - 1/2" NPT	1 lbs.	\$ 48.89	Y
TFXR3TRMBKT1112	3/4" FlashShield XR3 Term. Bkt. - 3/4" NPT	1 lbs.	\$ 53.98	N
TFXR3TRMBKT166	1" FlashShield XR3 Term. Bkt. - 1" NPT	1 lbs.	\$ 106.84	N

FlashShield XR3 Termination Fittings with No Flange

Includes adapter, nut and bushing.

TFXR3TRM8NF12	1/2" FlashShield XR3 Term. Fitting - 1/2" NPT	1 lbs.	\$ 41.06	Y
TFXR3TRM11NF12	3/4" FlashShield XR3 Term. Fitting - 3/4" NPT	1 lbs.	\$ 46.87	N
TFXR3TRM16NF6	1" FlashShield XR3 Term. Fitting - 1" NPT	1 lbs.	\$ 77.73	N

FlashShield XR3 Size by Size Tee Fittings

TFXR3T812	FlashShield XR3 1/2" X 1/2" X 1/2" Tee	1 lbs.	\$ 111.12	N
TFXR3T1112	FlashShield XR3 3/4" X 3/4" X 3/4" Tee	1 lbs.	\$ 154.08	Y
TFXR3T166	FlashShield XR3 1" X 1" X 1" Tee	1 lbs.	\$ 308.43	N
TFXR3T11886	FlashShield XR3 3/4" Run x 1/2" Run x 1/2" Tee	1 lbs.	\$ 130.04	Y
TFXR3T111186	FlashShield XR3 3/4" Run x 3/4" Run x 1/2" Tee	1 lbs.	\$ 152.67	N
TFXR3T1611116	FlashShield XR3 1" Run x 3/4" Run x 3/4" Tee	1 lbs.	\$ 215.22	N
TFXR3T161186	FlashShield XR3 1" Run x 3/4" Run x 1/2" Tee	1 lbs.	\$ 258.65	N
TFXR3T1616116	FlashShield XR3 1" Run x 1" Run x 3/4" Tee	1 lbs.	\$ 258.25	N
TFXR3T161686	FlashShield XR3 1" Run x 1" Run x 1/2" Tee	1 lbs.	\$ 235.11	N

FlashShield XR3 Flex to Flex Couplers

TFXR3CPL812	FlashShield XR3 1/2" Coupler	6 lbs.	\$ 67.81	N
TFXR3CPL1112	FlashShield XR3 3/4" Coupler	9 lbs.	\$ 108.45	N
TFXR3CPL166	FlashShield XR3 1" Coupler	7 lbs.	\$ 144.26	N

FlashShield XR3 Stub-Outs

TFXR3APSTUB810	FlashShield XR3 1/2" x 1-1/2" Stub x 1/2" NPT	15 lbs.	\$ 75.99	N
TFXR3LAPSTUB810	FlashShield XR3 1/2" x 2-1/4" Stub x 1/2" NPT	16 lbs.	\$ 77.82	N
TFXR3APSTUB1110	FlashShield XR3 3/4" x 1-1/2" Stub x 1/2" NPT	19 lbs.	\$ 96.04	N
TFXR3LAPSTB1111	FlashShield XR3 3/4" x 2-1/4" Stub x 1/2" NPT	22 lbs.	\$ 99.99	N
TFXR3APSTUB1111	FlashShield XR3 3/4" x 1-1/2" Stub x 3/4" NPT	22 lbs.	\$ 98.50	N

FlashShield XR3 Outlet Boxes

TFXR3OUTLETBOX8	FlashShield XR3 Recessed Gas Outlet Box Kit w/ 1/2" Fitting	2 lbs.	\$ 107.25	N
TFXR3OUTBOX11	(TFXR3OUTLETBOX11) FlashShield XR3 Recessed Gas Outlet Box Kit w/ 3/4" Fitting	2 lbs.	\$ 152.05	N
TFXR3OUTBOXFR8	(TFXR3OUTLETBOXFR8) Recessed Firestop Gas Outlet Box Kit w/ 1/2" Fitting	4 lbs.	\$ 225.41	N
TFXR3OUTBOXFR11	(TFXR3OUTLETBOXFR11) Recessed Firestop Gas Outlet Box Kit w/ 3/4" Fitting	4 lbs.	\$ 245.61	N

FlashShield XR3 Tools

TFGTCUTTERSM	Cutter w/ Flat rollers – 3/8" – 1" FlashShield CSST (GTCUTTERSM2)	2 lbs.	\$ 176.25	Y
TFGTCUTTERLG2	Cutter w/ Flat rollers – Up to 2" FlashShield CSST	2 lbs.	\$ 274.73	N
TFSTRP481124	1/2" and 3/4" Gastite Stripper	3 lbs	\$ 47.17	N
TFSTRP4162024	1" and 1 1/4" Gastite Stripper	3 lbs	\$ 54.24	N

Stock: Y = Stock, N or * = Non-Stock, LTSD = Limited to Stock on Hand

Non-Stock Item Notice: Items marked non-stock must be ordered in case quantities

Condar

Air Supply Ventilator



Every home needs fresh air. Whether to provide make-up air for a stove or fireplace, helping to prevent negative pressure drafting problems, or to improve the quality of the indoor environment. Condar's Air Supply Ventilator is the smart way to provide your home with filtered, draft-free fresh air. Requires no electricity and only a 4" hole in the wall. Simple to use and install. Made of tough paintable ABS polymer plastic. Comes complete with two tubes, dust filter and hardware pack. Dimensions: Interior cover 6" x 6" x 2", Exterior grille 5.5" x 5.5". Tube dimensions - see pg. 806 description. Three-year limited warranty.

Item No.	Size	Pkg.	Wt.	Retail	Stocked
CDASV90	Air Supply Ventilator	1	2 lbs.	\$129.99	Y

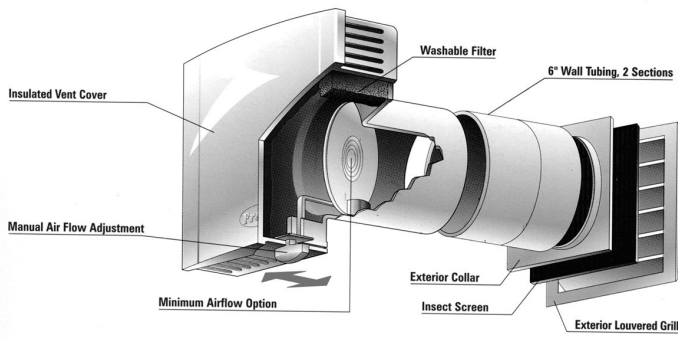

For more information on additional Condar products, see Sections 600 & 800 of this catalog.

2
0
2
3
-
2
0
2
4

